



CITA Smart DC 60-180 User Manual

Preface

This manual describes the functional features and use of Electric Vehicle Charging Station, including safety instructions, product overview, mechanical and electrical installation, operation procedures, technical parameters, fault diagnosis and routine maintenance. Please keep this handbook for future use. Before use, please read this manual carefully and understand the product notes before using this product.

Safety Instructions

- When using the product, cables connection must in accordance with the regulations and operated according to this user manual
- The illustrations in this manual are for illustration only, and may be different from the products you ordered. Users should refer to the actual product purchased
- We are keep improving our product, and the product functions will be continuously upgraded. The information provided is subject to change without notice
- We have complete after-sales service for customers. If you have questions or suggestions, please contact our customer service center. Tel:+44 800 368 6362 or email to support@citaevcharger.co.uk
- This user manual are fully owned by our company, and any person other than personnel may not publicly print/copy/send to others without written authorisation

Special Statement

Personal Safety

1. The installation must be performed by professional engineers from CITA EV in all the locations or agent authorized by factory, and only our designated engineers are allowed to do the commissioning, otherwise it will lead to failure of product or endanger safety of life.
2. Be sure to read this manual and safety precautions carefully before installing and commissioning the product, otherwise it may cause product failure or endanger safety of life.
3. This product can not be used as a power supply for any life support devices.
4. Prohibiting to put the built-in battery or external battery of this product into fire to avoid explosion and endanger safety of life.

Equipment Safety

1. For long time storage or keep it without using , Please be sure to place in a dry, clean environment with specified temperature range.
2. Please use this product in appropriate environment(details in environment requirement chapter in this manual)
3. Using in below working environments are prohibited. overheat, low-heat , moist sites those are incompatible to the specified technical index of this product
4. Sites with conductive dust, corrosive gas, salt spray or flammable gas
5. Sites with vibration and easy to be hit close to heat sources or places with strong electromagnetic interference

Disclaimer

We will not be responsible for defects or malfunctions caused by the following reasons: Exceeding the using scope and working environment of the product. Unauthorized modification or repairing, wrong installation, improper operation. Force majeure occurs Others of violating rules of the product manual

Safety Precautions

Please be sure to read and follow this safety precautions before installing, operating, and maintaining the equipment.



For safety concern of people and equipment, when installing, operating, and maintaining the equipment, be sure to follow the safety signs on the equipment and all safety precautions in the manual.

The "Danger", "Warning", and "Caution" in this manual do not represent all safety precautions that should be followed, but only as a supplement to the safety precautions.

This equipment should be used in an environment that meets the design specifications. Otherwise, it may cause equipment failure. Abnormal functions or components damage etc. caused by failure to comply with relevant regulations, which are not covered by the quality guarantee.

Our company will not bear any legal responsibility for personal safety accidents and property damage caused by illegal operation of equipment.

Please be sure to follow the following safety signs which are used in this manual.

Level	Meaning
 Danger	Improper use may cause dangerous accidents and is highly likely to cause personal injury or death.
 Warning	Improper use may cause dangerous accidents and is highly likely to cause personal injury or death or equipment damage.
 Notice	Please read manual carefully and follow it strictly ,though it does not cause equipment damage or personal injury.

Safety Precautions:

Notes

Be sure of reliable grounding before connection of input power (including AC mains and battery). Grounding of equipment must comply with local electrical regulations.



Danger

The selection of pre-stage power distribution protection equipment of CHARGER must be compliance with local electrical regulations

In the process of installation, if it is found that the person or equipment may be injured, the operator of the equipment shall immediately terminate the operation, report to the project leader, and take effective protective measures.

Installation, operation and maintenance of watches, bracelets, bracelets, rings, necklaces and other conductive objects are strictly prohibited.
Special insulating tools must be used during installation, operation and maintenance, such as wearing insulating gloves, safety clothing, safety helmet, safety shoes, etc.

Installation, use and operation of outdoor equipment (including but not limited to handling equipment, installation of cabinets, installation of power lines, etc.) in inclement weather such as lightning, rain, snow and high winds are strictly prohibited.

Improper and incorrect operation is forbidden, otherwise it may cause accident such as fire or electric shock.
Do not install or remove the power cord with live power. When the power cord touches the conductor, it will produce electric arc or spark, which can lead to fire or eye injury.

All in-house maintenance and repair of equipment is carried out using tools and should be carried out by trained professionals.



Warning

Power cable must be in the metal or metal geosyncline wiring, in order to prevent cable damage and reduce electromagnetic radiation

Power cable must be in the metal or metal geosyncline wiring, in order to prevent cable damage and reduce electromagnetic radiation. Before the electrical connection of the equipment, if it is possible to encounter live parts, it is necessary to disconnect the break device corresponding to the previous stage of the equipment. Before installing and removing the power cord, the power switch must be turned off. Before connecting the power cord, make sure the power cord label is correct before connecting it.

Contents

Product Overview	8
Technical Specification	9
Hardware Installation	11
Tool preparation	13
Mechanical requirements	16
Electrical Installation	20
Internal structure	21
Charger connector bin	22
Parameters	29
Charging Operation	30
Charging Flow Chart	31
User charging interface	32
Admin Operation Interface	35
Maintenance	38
Troubleshooting	40
Disposal	41
Warranty	42
Declaration of conformity	46

1. Product Overview

This chapter briefly introduces the characteristics & parameters of Electric Vehicle Charging Station.

1.1 Features

CITA Smart DC series Electric Vehicle charger station is an intelligent integrated DC charging station system promoted meet market demands. It adopts modular concept and cutting-edge electronic circuit technology, integrating power conversion, charge control, management, query, display and background communication in one cabinet. By communication with the BMS of electric vehicles, to achieve intelligent control of the entire charging process. It is composed of Human-machine Interaction Unit, Control Unit, Charging Module unit, Measurement Unit and Protection Unit. The design conforms to EN61851, EN62196, DIN70121, CHAdeMO1.2 and other standards.

1.2 Feature

1. The charger supports muti charging standards with two CCS2/CHAdeMo/GB-T Guns
2. 3 Connectors could be used simutaneously.
3. Built-in power meter with charging power metering function.
4. Configured with CITA1000/30 charging modules.
5. Support RFID Card charging(Mobile app optional) , support reservation function.
6. 10.4 " widescreen TFT touch screen with good human-machine interface, which can display QR code, status information, metering information, alarm, charging records, etc.
7. LED indicators of power, charging status and fault.
8. Self-identifying electric vehicle BMS protocol function, mufti-models compatible charging;
9. Emergency stop button can cut off the charger output in urgent situations.

10. Has SPD protection, AC input over voltage protection, AC input under voltage protection, short circuit retraction protection, DC output over voltage protection, DC output under voltage protection, battery anti-reverse protection, current anti-reverse and other protection functions;

11. Charging process protection function, when it occurs BMS communication failure, disconnection, battery temperature, voltage exceeds the allowable limit, etc.during charging process, the charge will immediately stop charging;

12. It has function of communicating with the monitoring system of the station, and can upload the charging information through Ethernet or 3G, 4G wireless network to realize remote monitoring.

13. Built-in DSP in the charging module realizes intelligent management and digital control functions;

14. Built-in active power factor correction module in the charging module, input THDi $\leq 3\%$; power factor 0.99.

15. The charging module adopts ZVZCS and LLC resonant soft switching technology, the efficiency up to 95%.

1.3 Technical Specification

CITA Smart 30 DC	
Model	CITA Smart 60/90/120/150/180 DC
Dimension	1100*500*2000
Input	
Rated input voltage	380Vac/400Vac/415Vac
Range of input voltage	304V-456V
Input AC limiting voltage	600V
Input frequency	50/60Hz; Range:45Hz-65Hz
Input PF	≥ 0.99

Output	AC	DC
Interface	Type 2	CCS2 or CHAdeMO or GB/T
Output voltage	400Vac	50-1000Vdc
Output current	32A	200A/250A/300A/380A
Charging modes	Mode 3	Mode 4
Display	10.4" touch screen	
Card reader	Type A, Type B, MF1, PSAM, ESAM	
Network interface	Network Interface: LAN, 4G LTE	
Communication protocol	OCPP1.6J	
Environment	Indoor/Outdoor	
Operating temperature	-20°C ~ +50°C	
Relative humidity	≤95%, Non-condensing	
Altitude	2000m	
Noise	<55 dB	
Protection degree	IP54, IK10	

Notice



There is a risk of electric shock, and the charging pile contains high voltage.



This terminal must be grounded before making other connections on the device.

2. Hardware Installation

This chapter briefly introduces the Mechanical Installation of separate DC charging system, including matters needing attention, preliminary inspection, environmental requirements, mechanical requirements and installation drawings, etc.

2.1 Precaution

The charging pile operates under the high voltage of the mains. The charging station contains components that can withstand high current/voltage. The correct installation of the charging pile needs to be grounded to resist electric shock and foreign objects. Installation and service are to be performed by the manufacturer's qualified technicians or their authorized service partners.

Notes

The internal operation of the charging pile must be carried out by a service engineer from the manufacturer or its authorized agent.



Warning

Refer to the manual for more information.

Read this information carefully to avoid equipment damage.

Notes



There is a risk of electric shock, and the charging pile contains high voltage.



This terminal must be grounded before making other connections on the device.

2.2 Transportation

Always choose smooth roads for transportation to avoid any bumps during transit. Railways and shipping through the sea are also good options.

Please use an electric forklift for unloading and handling to transport the equipment to the nearest location.

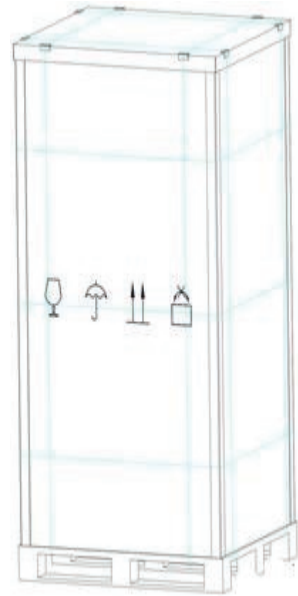

Notes

Before removing the package, visually inspect the package for damage and the anti-tipping label for discoloration. If there is any abnormality, please contact our customer service center for help immediately.







2.3 Installation tools

Notes

For safety concerns, installation tools for operations with electricity must use insulated gloves  to do insulation treatment.

The tools listed in Table 2-1 are for reference only and are subject to the requirements of the installation site.

Tool preparation

Name	Tools	Name	Tools
Hand drill		Cross screwdriver	
Multimeter		Anti-static wrist strap	
Insulated shoes		Anti-static gloves	

2.4 Unpacking

Unpack the DC charging pile under the guidance of our authorized service engineer. The specific steps are as follows:

Place the packing box vertically, try open the steel edge fixed lock, first open the top cover with a dumb wrench Size 17x19mm, then open the surrounding side panels respectively, and take out the surrounding protective corners. Be careful not to scratch the product.

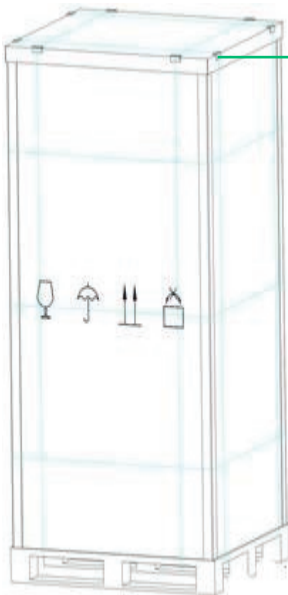

Use a flat-blade screwdriver to open it to remove the wooden box

The disassembly and assembly are carried out in the horizontal state:

Use a dumb spanner Size 17x19mm to disassemble and assemble the bolts and gaskets in the blue frame line as shown in the figure, and save the dismantled bolts, gaskets, internal honeycomb cardboard and corner protectors. location to install.

2.5 Initial inspection

Before installing the charger, Please have the following tests first:

Ensure that the Charger room environment meets the environmental requirements specified in the product's technical indicators, especially the ambient temperature, ventilation conditions, and dust conditions. Unpack the Charger under the direction of our authorized service engineer. Visually inspect the Charger for shipping damage. In case of damage, please inform the carrier immediately. Check the product label to confirm the correctness of the equipment. A label is attached to the equipment. The label indicates the Charger model, capacity and main parameters.

2.6 Environment Requirements

2.6.1 Storage environment

After the charging pile is delivered, if it is not installed for a long time without damage, it should be stored vertically in a stable position, and the environmental conditions should be as follows:

Storage temperature: $-25^{\circ}\text{C}\sim 60^{\circ}\text{C}$

Relative humidity: $\leq 95\%$ non-condensing

It is recommended that the user should store it at a temperature of 10°C to 30°C .

2.6.2 Installation environment

The placement position must be stable;

Sufficient ventilation distance should be maintained on all sides of the charging pile chassis;

- Maintain normal working temperature, working temperature: $-20^{\circ}\text{C}\sim +50^{\circ}\text{C}$
- Keep a clean working environment and avoid the environment of moisture, dust, flammable gas, flammable liquid or corrosive substances;
- A pollution source is an area within the following radii:
 - 0.5 km from salt water (eg ocean).
 - 3 kilometers away from heavy pollution sources such as metallurgy, coal mines, thermal power plants, etc.

- 2 kilometers away from medium pollution sources such as chemical, rubber, electroplating, etc.
 - 1 km away from light pollution sources such as food, leather, heating boilers, etc.
- For applications in offshore environments, there may be point-like corrosion of the module shell or shortened life of the whole machine, which needs to be selected carefully. For details, please consult the relevant service department.
- There is no strong vibration and shock at the installation and use site, no strong electromagnetic interference, and the induction intensity of the external magnetic field shall not exceed 0.5mT;
- The vertical inclination of installation shall not exceed 5%;
- There shall be no explosive dangerous medium in the place of use, and the surrounding medium shall not contain harmful gases and conductive mediums that corrode metals and destroy insulation, and molds are not allowed.

2.7 Mechanical requirements

2.7.1. The composition of the charging pile

The charging pile includes a cabinet, a monitoring unit, a control unit, a power module, and a PLC module.

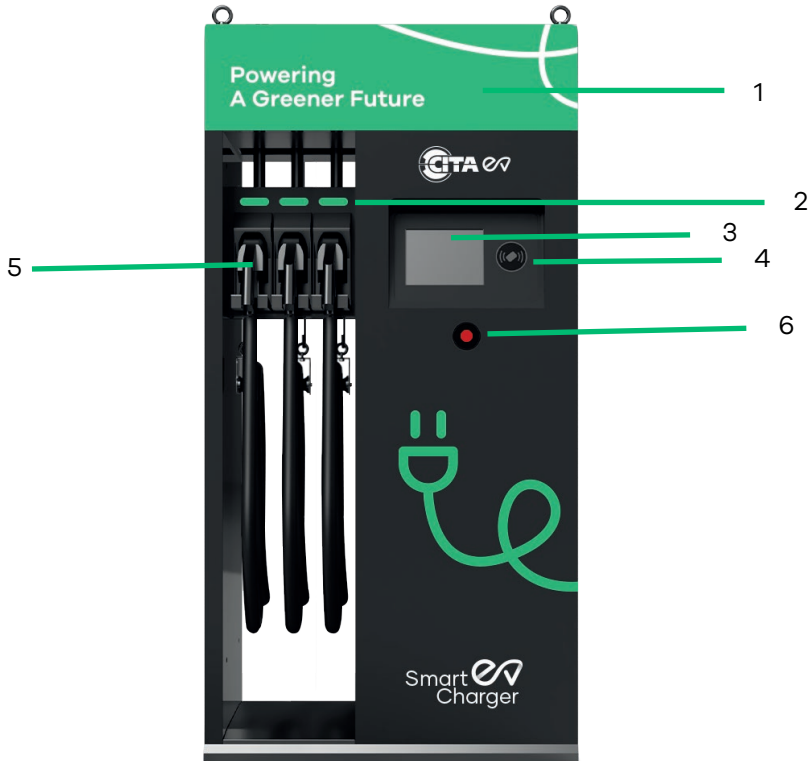

1. European Standard Charging Station

2. Charging Status Indicator

3. 10.4" Touch Screen Display

4. RFID Swiping Card Area

5. Connectors: CCS2, AC TYPE- 2

6. Emergency Stop Button

2.7.2 Transport Cabinet

Notice

The equipment for transport charger cabinet must have enough lifting ability. Ensure to have enough human labors and lifting equipment while removing tray. Be careful of overturning because of high enter gravity.

Make sure the weight of the charger is within the load capacity. Use a forklift or other similar lifting device to remove the charger.

2.7.3 Installation diagram

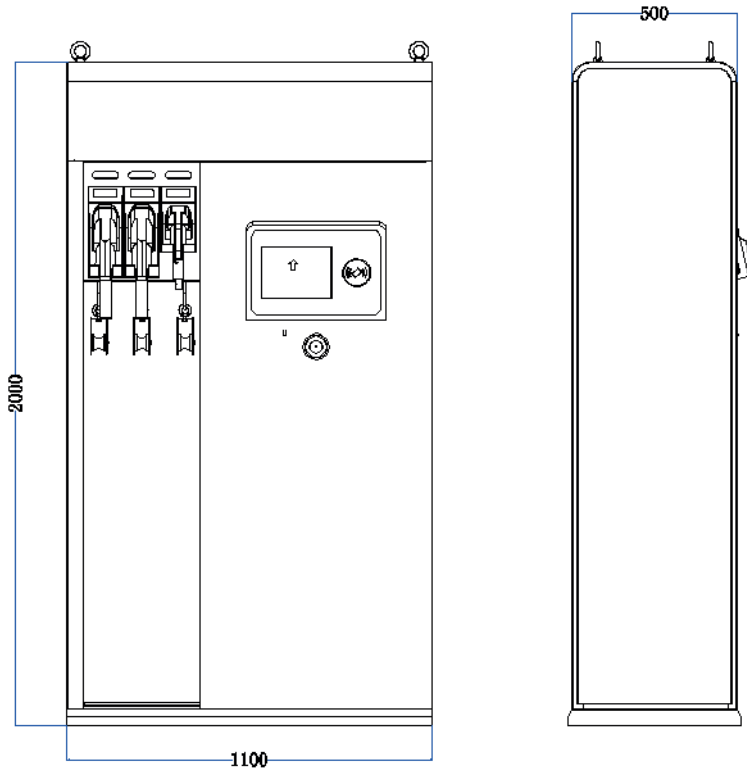

Appearance size

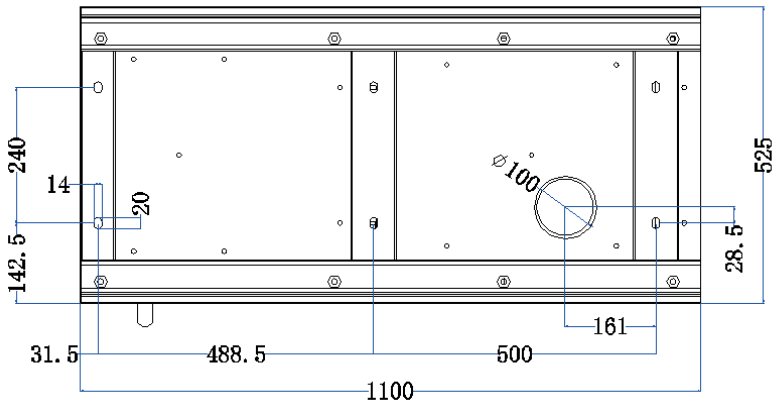

Front

Base anchoring hole diagram

For the stability of the charger, the bottom and top sides are fixed at the same time. After the cabinet is placed stably, the expansion bolts are tightened.

2.7.4 Installation and removal of power modules

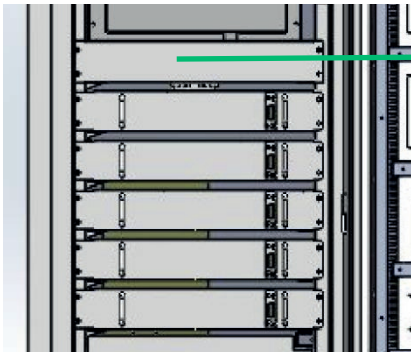

Hot swap
power module

Installation Steps

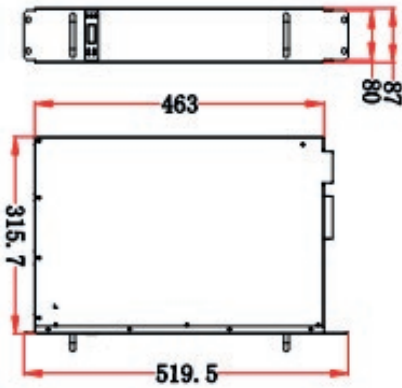

The charging module that has been installed should avoid being in a standby or unpowered state for a long time.

CITA1000/30CV(UPRIGHT)

Make sure that all mounting holes on the panel are fastened with screws.

Slowly push the module into the slot.

Install and tighten the screws on the top and bottom of the panel.

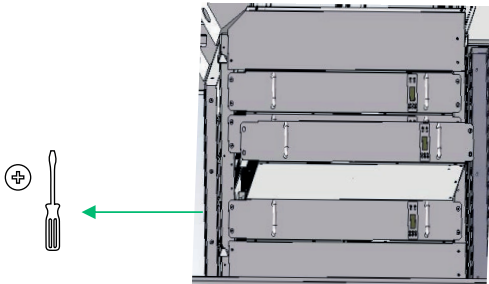

**Fasten with
M5 screws
(vertical
installation)**

Insert the AC input, DC output and communication cables into the corresponding positions.

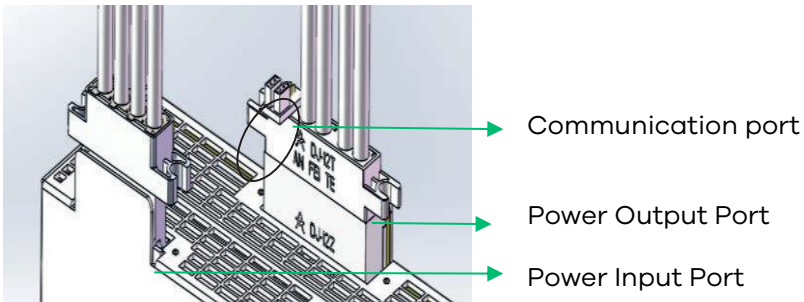

3.2 Internal structure

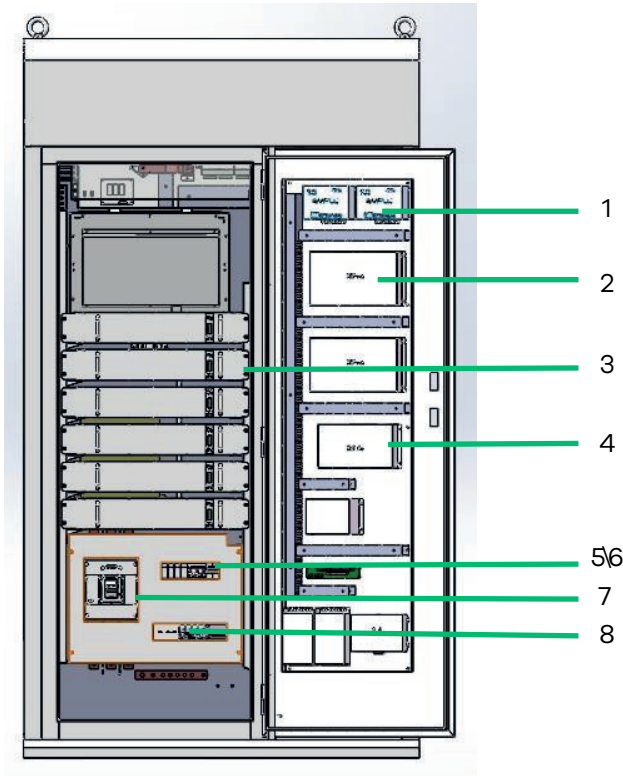

- 1. CITA-PLC
- 2. CITA-MCM
- 3. CITA 1000/30 power module
- 4. CITA-CSU
- 5. Earth leakage protection
- 6. SPD
- 7. AC input breaker
- 8. AC metering

Notes

Follow the local electrical requirements based on the rating of the AC input breaker. The cable size and colour coding vary depending on the region where the Charge Point is installed. Please consult the CITA EV Support team if you have any questions or concerns related to this.

3.3 Charger connector bin

When the device is powered off or powered on, the charging gun also has a locking function to protect the connector.

The EV charger supports two different charger standards and interfaces: CCS2, AC Type 2.

Charger connectors comply with BS EN 62196 standard.

Prohibit prolongation of connector wires without authorization.

Notes

Adapters and conversion adapters are not allowed to operate the charger with different standard of EV.

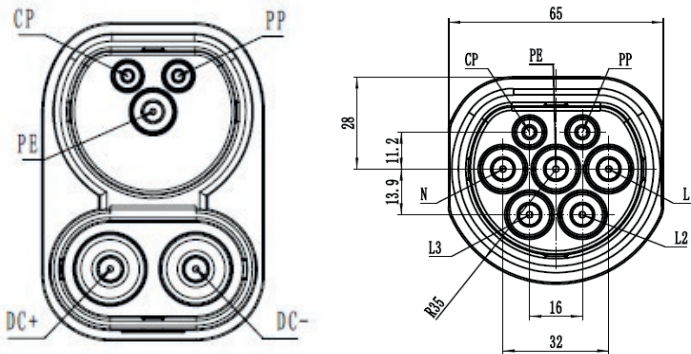

3.4 Charging strategy

CITA Smart DC series electric vehicle charger supports CCS2, AC Type 2 three charging output modes, The 3 Output Plugs could be used simultaneously.

3.5 Module Introduction

CITA1000/30 charging module is the internal DC power module of out-door integrated DC charging piles, which converts AC to DC and then charge electric vehicles, providing reliable DC supply for equipment requires DC power. The input of charging module is three-phase mains; output DC is adjustable between 50VDC~1000VDC, to meet various voltage demands of different battery packs.

The module has power-on self-test function, AC input over/under voltage protection, overload/ over-temperature protection; multi modules can constitute parallel redundant systems and realize multiple charging modules using in parallel within the cabinet. The module adopts three-phase active power factor calibration technology and DC-DC conversion technology, digital DSP control technology. The DC-DC power circuit uses interleaving tri-level series resonant soft switching technology, the efficiency of which can reach 300KHz, with high reliability, high availability, high maintainability and high efficiency.

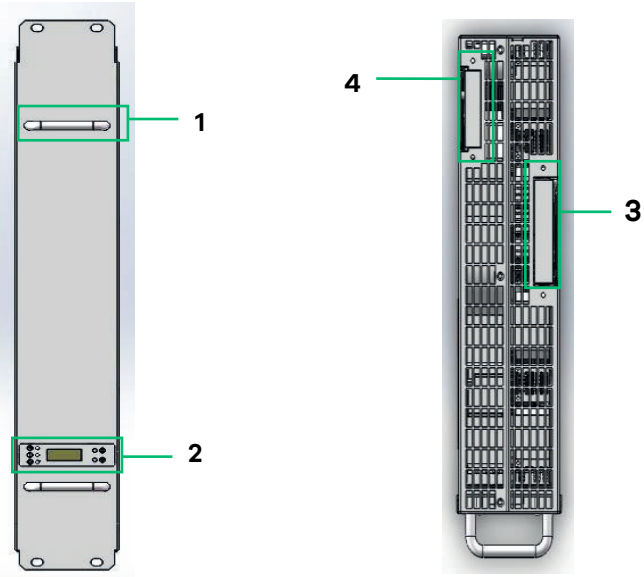

- 1. Handle
- 2. Display and Configuration Panel
- 3. DC Output and Communication port
- 4. AC Input port

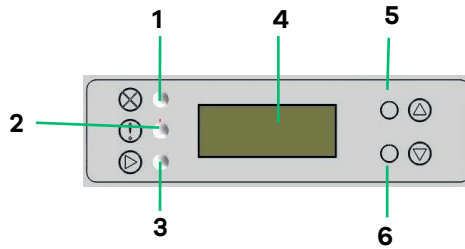

3.6 LED Panel Description



- 1. Fault indicator (red)
- 2. Alarm indicator (yellow)
- 3. Normal operation indicator light (green)

- 4. Module Data Indicator
- 5. Up button
- 6. Down button

LED Light Description

Serial number	Material name
1. Normal running light 	The green indicator light indicates normal operation and working status of the charger
2. Alarm indicator 	The yellow indicator light indicates the alarm state, and it does not light up when the module is in a working state
3. Fault Indicator 	The red indicator light indicates the fault state, and it does not light up when the module is in a working state

3.7 Module Data Indicator

After the module is powered on, it will display 8888. After the initialization is completed, it will start to alternately display the voltage (5s), current (5s), and address (5s).

NO	Description
1 Shows "— —XX"	It's the Module address
2 Shows "XXXX"	Represents the output voltage (four digits)
3 Shows "C XX"	Represents the output current (starts with the letter C)
In this area, the module address bit, voltage, and current are displayed in this area to facilitate observing the status of the module.	

3.8 I/O connector

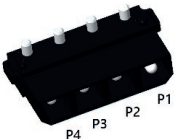
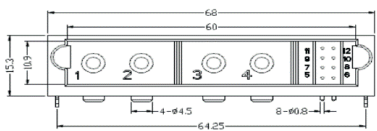
Interface	Terminal type	Pin definition
AC input terminal	Plug-in power connector, plug: DJ-TH-4Z or equivalent 	Modular plug: DJ-TH-4Z System backplane socket: DJ-TH-4T; Manufacturer: Anfeite P1: chassis ground P2: AC input live wire: C; P3: AC input live wire: A; P4: AC input live wire: B;
DC output terminal and address line	Pin type power connector, socket: DJ-12Z or equivalent	Plug: DJ-12T Socket:DJ-12Z, manufacturer:Anfeite 1-2: DC output positive; 3-4: DC output negative;5-12:CAN 

Insert the AC input, DC output and communication cables into the corresponding positions.

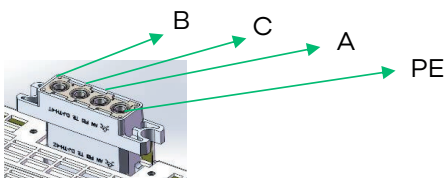
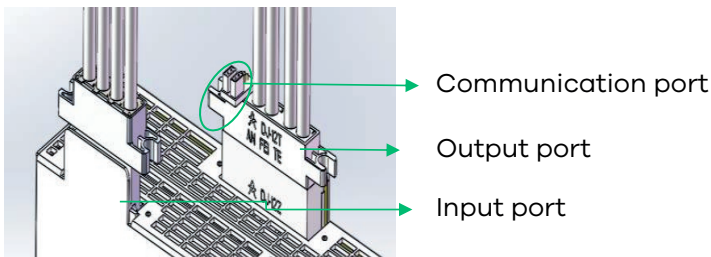

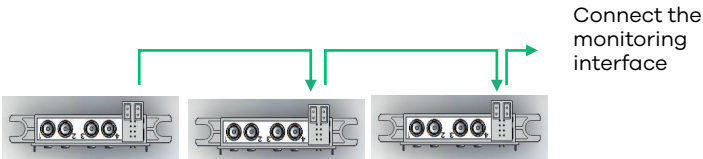
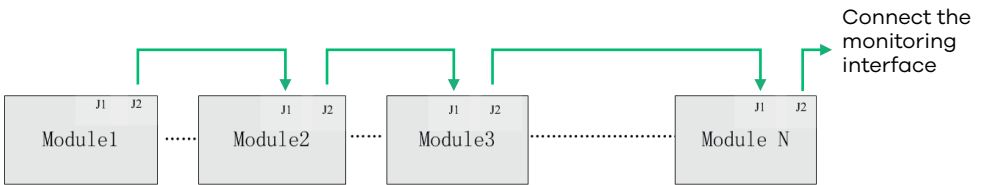
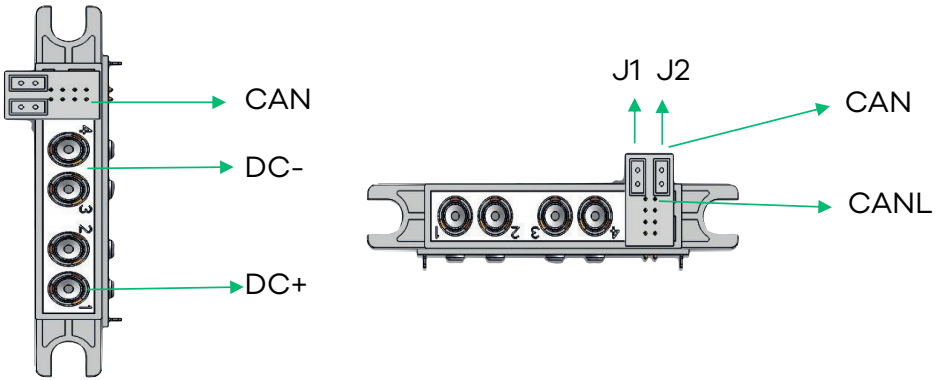

Warning

Note: After the module is installed, you need to set the module address bit, from left to right, set -01, -02, -03...

AC input cable recommended

Connection location	Recommended cable
PE	1015-10AWG
B	1015-10AWG
C	1015-10AWG
A	1015-10AWG

AC input cable recommended

Connection location	Recommended cable
DC-	1015-6AWG
DC+	1015-6AWG
CAN	2*0.2 shielded wire

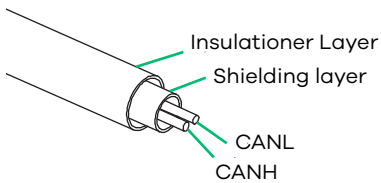

CAN-shielded wire icon

Block diagram of working principle

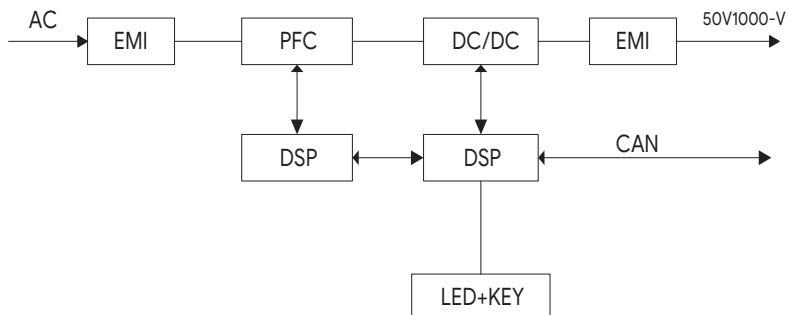

3.9 Parameters

Power module	DPM1000/30
Output capacity	30kW
Input voltage	380Vac\400Vac\415Vac
Input voltage range	260V~480V
Input Frequency	50/60HZ
Input power factor	0.99
Input current harmonics	≤3%
Efficiency	≥97%
Output voltage	50-1000V
Output current	MAX 100A
Stabilisation accuracy	<0.5%
Steady flow accuracy	<1%
DC output peak-to-peak noise voltage	<1%
Power ON-OFF Overshoot amplitude	<10%
Software start time	3~8S
Shutdown discharge time	<1S
Working temperature	-25°C~+75°C
Storage temperature	-40°C~+75°C
Relative humidity	0-90%, 40±2°CNo condensation
Altitude	2000m
Dimension	CITA1000/30C 300*463*87(W*D*H, handle excluded)
	CITA1000/30CV 87*315.7*436 (W*D*H, handle excluded)
Weight	13KG

4. Charging Operation

This chapter introduces in detail the charging operation process of the DC charging pile, the function and usage of each component of the operation control display panel, and provides how to charge and view the alarm list.

4.1 Safety check before charging

Please do the following checks carefully before use

1. Ensure that the charging pile is not scratched, rusted, deformed, etc.;
2. Ensure that the power supply socket is safe, and that there is no foreign matter residue in the charging head and the charging socket of the vehicle;
3. Please do not continue to use the cable or charging gun head if the casing is damaged or the cable is exposed;
4. Keep the plug of the charging gun dry. If there is standing water, please use a dry and clean cloth to dry the water of the charging plug when the whole pile is powered off.

4.2 Charging Flow Chart

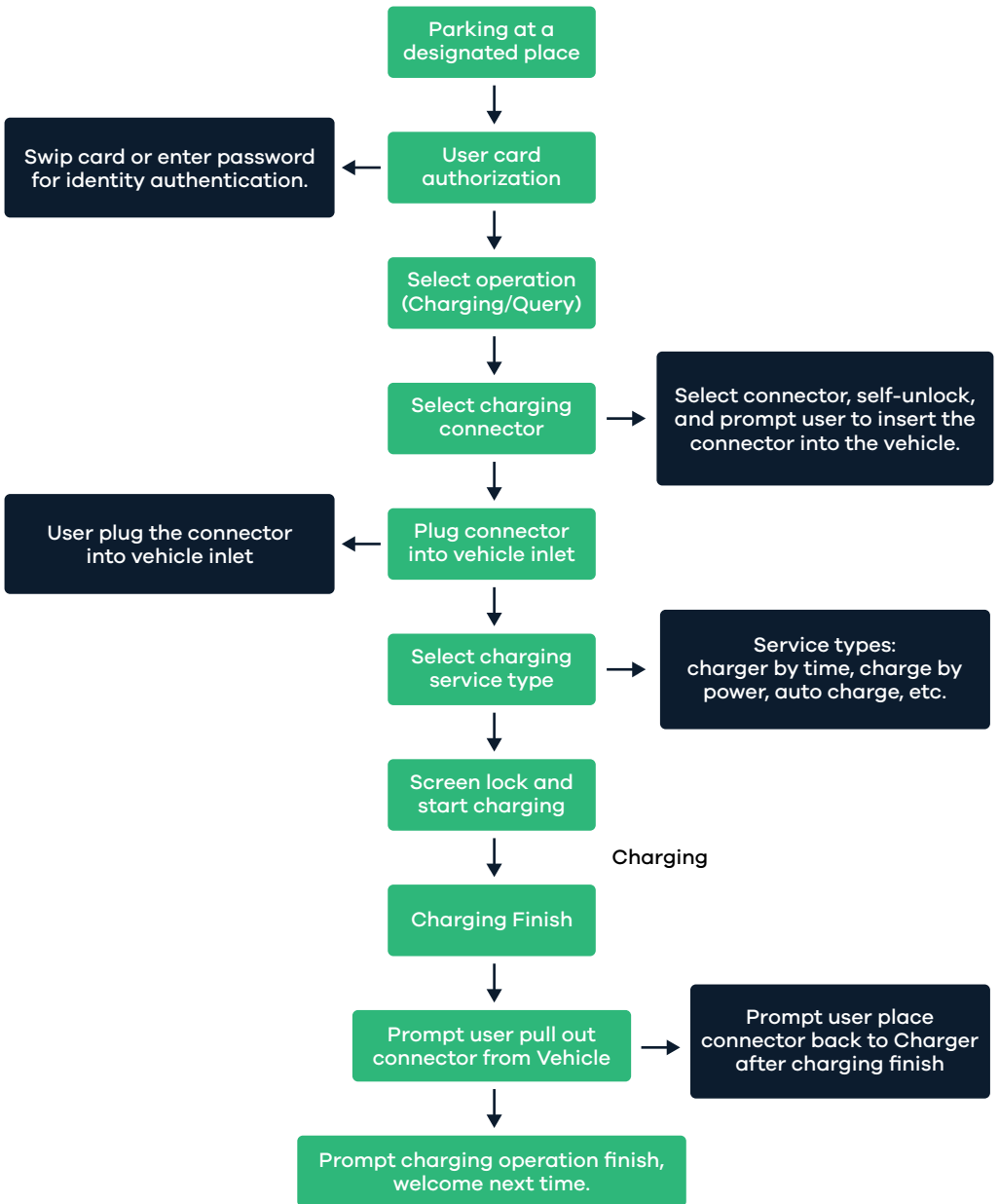

4.3 User charging interface

The operation control and display panel of the European standard charging pile is located on the front of the cabinet. The monitoring display screen is a 7-inch color touch screen. By operating the control display panel, the charging pile can be charged.

The boot interface is shown as below:

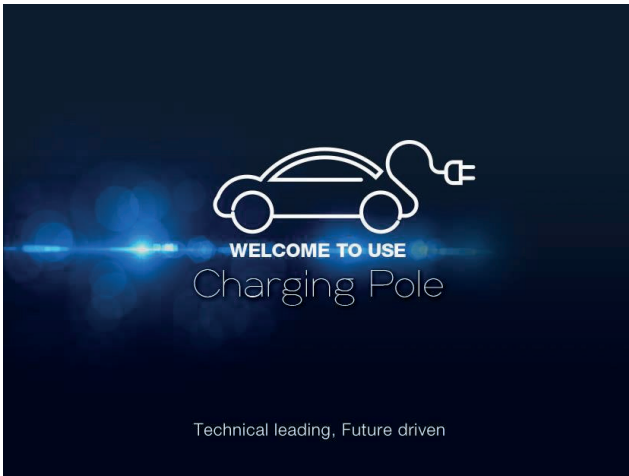

After charger start up, choose the plug .

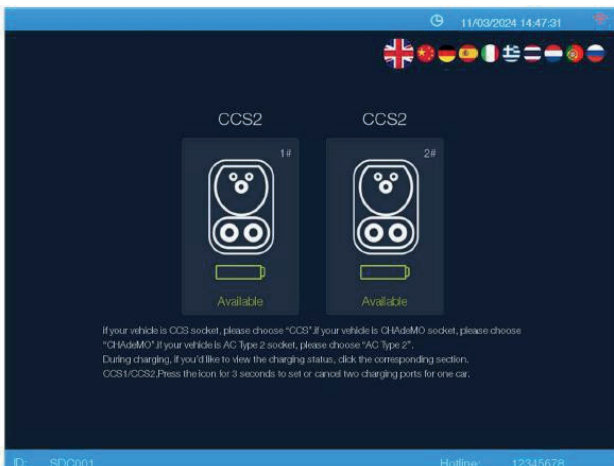

Confirm charging by swiping card or enter password, then comes to charging interface to start charging.

Entering password:(the default password is "1")

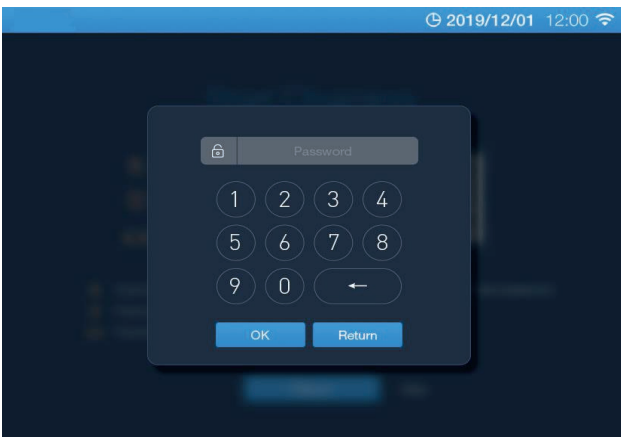
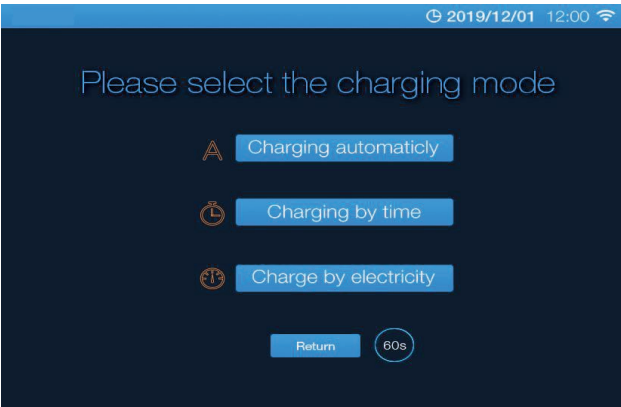

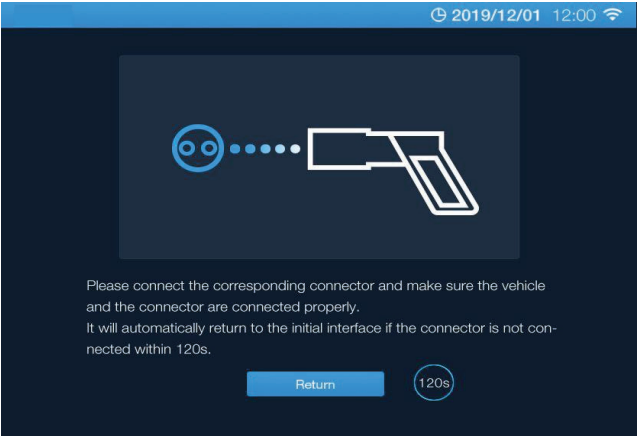

Notice

Connect the plug with car

After user selects and confirms the charging mode, the system will perform charging command. The system interface will real-time display charging details. The user can observe battery SOC, remaining time required for full charging etc.. The charging states are displayed in the lower left corner. **The interface is displayed as below:**



After charging, swipe card or password to end charging.

4.4 Admin Operation Interface

Notice

Note: Administrator's privileges are higher than users'.

Pull down the upper right corner of the homepage to enter the maintenance mode password interface, as shown in the figure below, the initial password is "888888"

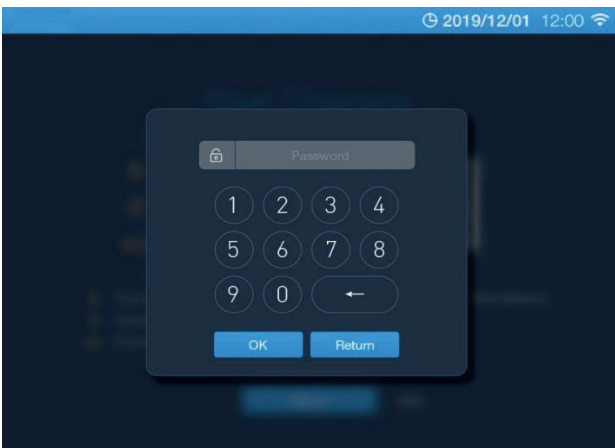
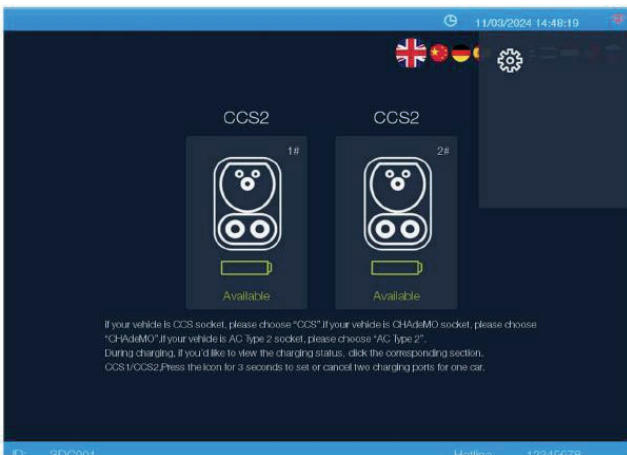

After entering the correct password, enter the main interface

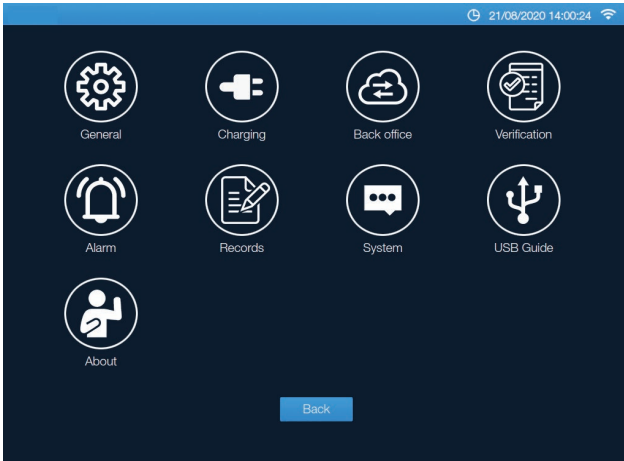

Name	Menu item	Interpretation
General	Common parameters	Set the date and time.charging password. service hotline. Smart Charge Settings
	Network settings	IP.DNS Server Address
	Network settings	Calibration screen
Charging	Type of charging connector	Type of charging connector.output characteristics.smart charging
Back office	Operation background choice	Domain Name & Stake Number
Verification	Charging permission	Charging permission setting and user waiting time setting
Alarm	Alarm	Alarm settings

Name	Menu item	Interpretation
Records	Reason for ending	View charging and alarm records
System	Check System Status	The input and output voltage and current of the system and module
USB Guide	Output	Logging, Configuration File Export and Upgrade
About	Device information	Device model and software version

4.5 Charging status indicator

With luminous and indicating function, the charger is convenient for customers to conduct charging operations at night. Three-color indicator: red, yellow, green.



Red light : fault & alarm status; it will not light on when charger work normally.



Yellow light : the load is charging.



Green light : the battery is fully charged; the charger is in standby mode.

4.6 Emergency stop button

There is an Emergency Stop button below the user interface. When the charger fails, user can press the emergency stop button, which make the charger output disconnected, meanwhile the indicator light keeps to be red. After corresponding troubleshooting, the emergency stop button will restore by rotated to the right.

5. Maintenance

In the long-term operation of charging piles, regular maintenance are required. This chapter mainly describes the recommendations for regular inspection, maintenance and replacement of charging piles.



Danger

1. The daily inspection of the charging pile can be performed by personnel who have received relevant training, and the inspection and replacement of its components should be performed by authorized professionals.
2. The parts behind the protective cover that can only be opened with tools are not user-operable parts, and only qualified maintenance personnel are allowed to open such protective covers.
3. When maintaining the charging pile, pay attention to the N line being charged.

5.1 Daily Maintenance

Charger plug:

1. When charger not in use, try to avoid the plug head directly exposed to the outside, should plug it back into the socket to prevent damage. Check if the charging cable or the charging plug head has problems such as damaged or bare cable. If yes, please do not continue to use it.
2. When pulling the plug , pay attention to the handle and position of the handle to avoid barbaric drag;
3. Keep plug head dry and prevent the accumulation of water.

Charging pile to Charging Station:

1. Pile body: to check whether it is rusty or leaking;
2. Display: to check whether information displayed is complete and whether it is black screened;
3. Indicator light: to check whether it can be normally indicated;
4. Equipment door lock: to check whether there is damage, or can be locked;
5. Emergency stop switch: to check whether there is damage

Functional detection:

1. Charging function: Whether there is a phenomenon that charging is not normal;
2. Background connection: Whether the charger pile can be connected to the server.

Data record:

1. Electricity record: record the electricity of the meter twice a day as analysis of subsequent operational data;
2. Fault record: record follow-up for the discovered fault.

5.2 Troubleshooting

Alarm	Troubleshooting
Background communication fault	Check whether the background system is normal.
Insulation fault	Check whether between output and PE terminal are lack of insulation.
Input over voltage	Check whether three phase input voltage of input breaker is normal.
Input under voltage	Check whether three phase input voltage of input breaker is normal.
Input phase loss	Check whether input power wire is normal.
Output short-circuit	Check whether output is short circuit.
Single cell over voltage	Check whether the battery in ev is normal.
Single cell over temperature	Check whether the battery in ev is normal.
BMS fault	Check whether BMS is normal. Replug connector to eliminate the alarm.
Emergency button fault	Check whether the emergency button is pressed.
Power grid frequency fault	Check whether the power grid frequency is normal.
Background communication fault	Please contact the supplier.
Card reader communication fault	
Touch screen communication fault	
Meter communication fault	
BMS fault	
Module communication fault	

Temperature fault	Please contact the supplier.
Memory fault	
PFC bus over voltage	
PFC bus under voltage	
DC/DC fault	
Input over current	
Output over voltage	
Output under voltage	
Output over current	
Output circuit open	

As the products are constantly updated and upgraded, we are free to change them without prior notice. The products are subject to the actual products.

No part of this manual can be modified without the permission of the manufacturer. The company reserves the right of final interpretation.

Disposal

The packaging materials are environmentally friendly and can be recycled. Put the packaging in applicable containers to recycle it. Do not dispose of this device with household waste. It shall be handed over to the applicable collection point for the recycling of electrical and electronic devices. For more detailed information about recycling of this device, please contact your local city office, your household waste disposal service, or the shop where you purchased the device.

6. Warranty

LIMITED WARRANTY UP TO 3 YEARS FOR AC CHARGERS AND 2 YEARS FOR DC CHARGERS

1.1 Subject to the exclusions from Warranty coverage set forth below, CITA EV warrants that your Charging Station will be free from any defects in materials or workmanship for a period (the "Warranty Period") of three (3) years for the AC Charging Station and two (2) years for the DC Charging Station.

The charging cables and accessories, for which the Warranty is limited to one (1) year from commissioning. (a) The charging socket (Type 2, CCS2, GB/T, CHAdeMO) of a CITA EV comes with one (1) year of Warranty from the date of commissioning the hardware. (b) The HMI screen, with or without touch, also comes with one (1) year of Warranty. (c) If a non-CITA-approved installer or partner has installed the charger, then you can avail of only one (1) year warranty for AC and DC Charging Stations. If during the Warranty Period, your Charging Station becomes defective in breach of the Warranty, CITA EV will, upon written notice of the defect received during the Warranty Period, either repair or replace, at CITA EV's election, the Charging Stations. The Warranty covers both parts and factory labour necessary to repair your Charging Station but does not include any on-site labour costs related to uninstalling or repairing the defective Charging Station or reinstalling the repaired or replacement Charging Station.

Notes

The AC & DC Charger hardware must be installed without direct sunlight exposure to avoid overheating. Installing it without a shade or exposing it to direct sunlight will void the warranty claims.

TERMS AND CONDITIONS

1.2 Subject to clause 1.3, CITA EV shall, at its option, repair or replace defective Products if:

(a) Customer gives notice in writing during the warranty period within fourteen (14) days after the Customer has discovered or should reasonably have discovered that some or all of the Products do not comply with the Warranty as set out in clause 1.1;

(b) Customer returns such Products to CITA Smart EV Charger (at the location specified by CITA EV) at Customer's cost and following the RMA (return merchandise authorisation) instructions from CITA EV if the nature of the Product allows such return; and

(c) CITA EV is given a reasonable opportunity of examining such Products and provided by Customer with all information it may reasonably require to proceed to such examination. Concerning repair, CITA EV is entitled to apply problem-avoiding restrictions and/or Workarounds (d) CITA EV reserves the right to replace any unit under Warranty with a new unit if repair is not possible.

1.3 CITA EV shall not be liable for the Product's failure to comply with the warranty in clause 1.1 if:

(a) Customer makes any further use of such Products after giving a notice in accordance with or failed to provide notification within fourteen (14) days as set out in clause 1.2;

(b) The Error arises because Customer failed to follow CITA EV's oral or written instructions as to the storage, installation, commissioning, use or maintenance of the Products or (if there are none) good trade practice (such as but not limited to use of the Products with parts, accessories or software not provided or approved by CITA EV);

(c) The Error arises as a result of CITA EV following any customization or Product specification supplied by Customer;

(d) Repairs or other interventions on the Products are performed by persons not trained for this purpose, against CITA EV's oral or written instructions, or with parts not supplied or approved by CITA EV; or

(e) The Error arises as a result of fair wear and tear, willful damage or negligence by Customer and/or a third party, or abnormal working conditions (such as but not limited to damages resulting from vandalism, animals, high-pressure cleaners, natural disaster or Error in connected vehicles).

1.4 In all cases, the following are excluded from the coverage of the Warranty:

(a) Travel costs and labour costs of repair, including time spent on preliminary work or on disassembly and reassembly, if the repair of the Products is to take place at the installation site due to the nature of the Products;

(b) Cleaning, routine maintenance and preventative maintenance operations of the Products as defined in the Documentation, as well as the supply of products necessary for these operations;

(c) Restarting operations after the Product has been secured, for example, by circuit breakers, ground fault circuit interrupters (GFCIs), fuses or emergency stops; and

(d) In general, all operations on-site, especially if no parts need to be replaced.

1.5 The Agreement shall apply to any repaired or replaced Products supplied by CITA EV. This warranty statement is subject to change without prior notice.

STEPS TO CLAIM YOUR WARRANTY

1. Activate your Warranty online during the installation and activation process on the CITA EV Warranty Registration Page. <https://citaevcharger.co.uk/warranty-registration>

2. If at any time during the term of your Warranty, you believe you have a defective Charging Station, contact Customer Service at +44-800-368-6362 or support@citaevcharger.co.uk, or for customers outside the UK, contact 0044-800-368-6362, and share your Charging Station Serial Number with our support team. If the Charge Point is connected to the CITA EV management system or any CITA EV-partnered CPMS, then the CITA EV team will determine if your issues may be resolved remotely.

3. If your issues cannot be resolved remotely, to assure prompt and proper diagnosis and repair, physical on-site troubleshooting of suspected defects and coordination with CITA EV must be performed by an electrician at your sole expense. CITA EV will ship all replacement parts or Charging Stations to your electrician, who will be responsible for the receipt and return of all spare parts and Charging Stations.

4. In connection with your support request, you will be asked for each of the following:

- a. A detailed description of the problems you are experiencing with the Charging Station;
 - b. The model number and serial number of the Charging Station;
 - c. Proof of purchase (such as a copy of the CITA EV invoice for your Charging Station);
- and
- d. Shipping information.

5. If CITA EV determines that the defect appears to be covered by your Warranty and your Warranty is still in effect, you will be provided with a Returned Material Authorization number (RMA number) to reference when returning the defective Charging Stations for repair or replacement.

6. Ship the defective Charging Stations to CITA EV and reference the RMA number in the shipping documentation. The Charging Station must be returned in its original shipping container or in another shipping container designed to prevent damage to the Charging Station.

7. CITA EV will either repair or replace the defective Charging Stations at no charge to you and ship the repaired or replaced Charging Stations back to you at CITA EV's expense.

IMPORTANT NOTICE TO END-USER

1. You are responsible for properly installing and maintaining the Charging Stations, including de-installing any defective Charging Stations and installing repaired or replacement Charging Stations returned to you.

2. Any service or repairs beyond the scope of the Warranty above will be performed upon customer approval at CITA EV's then prevailing labour rates and other applicable charges.

3. Charging Stations that are found by CITA EV to be out-of-warranty or otherwise ineligible for warranty service will be returned, repaired or replaced upon customer approval at CITA EV's standard charges at your expense.

4. Please read carefully through the detailed descriptions of the WARRANTY, the EXCLUSIONS FROM LIMITED PRODUCT WARRANTY, and the LIMITATIONS ON WARRANTY AND LIABILITY on the following pages to ensure that your Charging Station is eligible for warranty service without additional cost to you.

REPLACEMENT PARTS OR CHARGING STATIONS

You acknowledge that replacement parts or Charging Stations provided by CITA EV under the Warranty may be remanufactured or reconditioned parts or Charging Stations or if the exact Charging Station is no longer manufactured by CITA EV, a Charging Station with substantially similar functionality ("Replacement Products"). All replaced parts, whether under Warranty or not, become the property of CITA EV. Any replacement parts or Charging Stations so furnished will be warranted for the remainder of the original Warranty Period or ninety days from the delivery date of such replacement parts or Charging Stations, whichever is later. Should CITA EV cannot repair or replace your Charging Station, CITA EV will refund the purchase price of the Charging Station to you.

EXCLUSIONS FROM WARRANTY

IMPORTANT: The Warranty on your Charging

Stations shall not apply to defects or service repairs resulting from the following:

- Improper site preparation or maintenance, improper installation, cosmetic damage such as scratches and dents, or normal aging.

- Abuse, vandalism, damage or other problems caused by accidents, misuse or negligence (including but not limited to physical damage from being struck by a vehicle) or use of the Charging Stations in a way other than as specified in the applicable CITA EV documentation.

- Installation, alteration, disassembly, modification or relocation of the Charging Stations that were not approved in writing by CITA EV or performed by CITA EV or by a certified

- Use of the Charging Stations with software, interfacing, parts or supplies not supplied by CITA EV.
- Damage from an extreme power surge, electromagnetic field or any acts of nature.
- Any other causes beyond the control of CITA EV.

IN ADDITION: The Warranty on your Charging Stations shall not apply if the original identification markings (for example, serial numbers and trademarks) have been defaced, altered or removed.

THE WARRANTY APPLIES ONLY TO YOUR CHARGING STATION AND NOT TO ANY CITA EV SERVICE PLAN. CITA EV SPECIFICALLY DOES NOT WARRANT THAT ANY CITA EV SERVICES WILL BE ERROR-FREE OR WILL OPERATE WITHOUT INTERRUPTION.

LIMITATIONS ON WARRANTY AND LIABILITY

NO AGENT OF CITA EV IS AUTHORIZED TO ALTER OR EXCEED THE WARRANTY OBLIGATIONS OF CITA EV. THE REMEDIES IN THIS LIMITED PRODUCT WARRANTY ARE YOUR SOLE AND EXCLUSIVE REMEDIES. CITA EV MAKES NO OTHER EXPRESS OR IMPLIED WARRANTIES OTHER THAN THE WARRANTY SET FORTH ABOVE. ALL OTHER WARRANTIES, INCLUDING WITHOUT LIMITATION ANY WARRANTY OF DESIGN, MERCHANTABILITY, FITNESS FOR A PARTICULAR PURPOSE (EVEN IF CITA EV HAS BEEN INFORMED OF SUCH PURPOSE) OR AGAINST INFRINGEMENT, ARE EXCLUDED TO THE EXTENT PERMITTED BY LAW. IF ANY IMPLIED WARRANTY CANNOT BE DISCLAIMED UNDER APPLICABLE LAW, SUCH IMPLIED WARRANTY SHALL BE LIMITED IN DURATION TO THE WARRANTY PERIOD DESCRIBED ABOVE. NO WARRANTIES APPLY AFTER THE EXPIRATION OF THE WARRANTY PERIOD.

Some states or jurisdictions do not allow the exclusion of express or implied warranties or limitations on how long an implied warranty lasts, so the above limitation may not apply to you.

CITA EV IS NOT LIABLE FOR ANY INDIRECT, INCIDENTAL, SPECIAL, PUNITIVE OR CONSEQUENTIAL DAMAGES, INCLUDING WITHOUT LIMITATION LOST PROFITS, LOST BUSINESS, LOST DATA, LOSS OF USE, OR COST OF COVER INCURRED BY YOU ARISING OUT OF OR RELATED TO YOUR PURCHASE OR USE OF, OR INABILITY TO USE, THE CHARGING STATIONS, UNDER ANY THEORY OF LIABILITY, WHETHER IN AN ACTION IN CONTRACT, STRICT LIABILITY, TORT (INCLUDING NEGLIGENCE) OR OTHER LEGAL OR EQUITABLE THEORY, EVEN IF CITA EV KNEW OR SHOULD HAVE KNOWN OF THE POSSIBILITY OF SUCH DAMAGES. IN ANY EVENT, THE CUMULATIVE LIABILITY OF CITA EV FOR ALL CLAIMS WHATSOEVER RELATED TO THE CHARGING STATIONS WILL NOT EXCEED THE PRICE YOU PAID FOR THE CHARGING STATIONS. THE LIMITATIONS SET FORTH HEREIN ARE INTENDED TO LIMIT THE LIABILITY OF CITA EV AND SHALL APPLY NOTWITHSTANDING ANY FAILURE OF ESSENTIAL PURPOSE OF ANY LIMITED REMEDY.

Some states or jurisdictions do not allow the exclusion or limitation of incidental or consequential damages, so the above limitation or exclusion may not apply to you.

ADDITIONAL INFORMATION

This Warranty shall be governed by and construed in accordance with the laws of the United Kingdom and United Arab Emirates, exclusive of its conflict of laws principles. This Warranty is the entire and exclusive Agreement between you and CITA EV with respect to its subject matter, and any modification or waiver of any provision of this statement is not effective unless expressly outlined in writing by an authorised representative of CITA EV.

Warranty Registration



In order to activate your warranty for 2 years in our system, kindly **Scan the QR Code and submit** or email **support@citaevcharger.co.uk** containing your Name, Phone Number, Email, Charger Serial Number, & Proof of Purchase.

7. Declaration of conformity

Manufacturer: CITA EV Limited

52 Deerdykes View, Westfield Park, Cumbernauld, Glasgow, G68 9HN, United Kingdom

Product Information:

CITA Smart 60 – 60kW DC, 125A, Two DC Guns: CCS2 / CHAdeMO / GB/T Cable, Three Phase Installation
CITA Smart 90 – 90kW DC, 200A, Two DC Guns: CCS2 / CHAdeMO / GB/T Cable, Three Phase Installation
CITA Smart 120 – 120kW DC, 225A, Two DC Guns: CCS2 / CHAdeMO / GB/T Cable, Three Phase Installation
CITA Smart 150 – 150kW DC, 300A, Two DC Guns: CCS2 / CHAdeMO / GB/T Cable, Three Phase Installation
CITA Smart 180 – 180kW DC, 350A, Two DC Guns: CCS2 / CHAdeMO / GB/T Cable, Three Phase Installation

Standards and Directives:

The CITA EV Chargers has been designed, manufactured, and tested in accordance with the following standards and directives:

IEC 61851-23:2014

IEC 61851-1:2010

IEC 61851-1:2017

IEC 61439-7:2018

ETSI EN 301 489-3 V2.1.1 (RFID)

ETSI EN 301 489-52 V3.2.0 (4G)

ETSI EN 301 489-17 (Wi-Fi)

ETSI EN 301 908-13 (Modulo 4G)

ETSI EN 300 328 V2.2.2 (Modulo Wi-Fi)

ETSI EN 300 330 V2.1.1 (Modulo RFID)

The above-mentioned standards and directives ensure that the CITA EV Chargers comply with the essential requirements related to safety, electromagnetic compatibility, and the restriction of hazardous substances.

Testing and Certification:

The CITA EV Chargers have undergone rigorous testing and evaluation with Accredited lab, an ISO/IEC 17025:2018 accredited testing laboratory to ensure compliance with the relevant standards and directives. We have obtained the necessary certificates and test reports, which are available upon request.

Conformity Markings:

The CITA EV Charger bears the CE marking, indicating its conformity with the applicable EU directives. Additionally, it carries the UKCA (United Kingdom Conformity Assessed) marking, demonstrating compliance with the relevant UK regulations.

We maintain a comprehensive technical documentation file, including design drawings, specifications, test reports, and compliance statements, which can be made available to the relevant authorities upon request.

This Declaration of Conformity is valid for the above-mentioned product and may not be reproduced or altered without the prior written permission of CITA EV Limited.

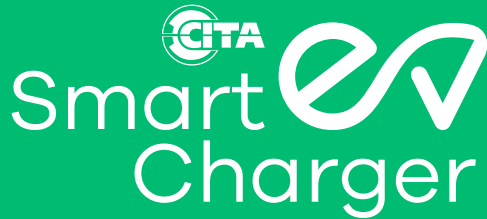

United Kingdom (HQ)

52 Deerdykes View, Westfield Park,
Cumbernauld, Glasgow, G68 9HN,
United Kingdom

Phone : +44 800 147 CITA(2482)

Support (Hotline) : +44 800 368 6362

United Arab Emirates

Unit 2106, Al Thanyah Fifth, HDS Tower,
Cluster F, Jumeirah Lakes Towers,
P.O. Box 191946, Dubai, UAE

Phone : +971 4 5579828

Support Email : support@citaevcharger.co.uk

Disclaimer: Information has been carefully checked and is believed to be accurate; however, no responsibility is assumed for inaccuracies. Due to continual product development, change in specifications, colours and details of our products and those mentioned in this manual are subject to change without prior notice. For any further inquiries, please contact our nearest sales office via e-mail to info@citaevcharger.co.uk or through the phone.